

PREPARED BY: DATE: <i>M. Mitani Jun 18, 1996</i>	<b>SHARP</b>  ELECTRONIC COMPONENTS GROUP SHARP CORPORATION <b>SPECIFICATION</b>	SPEC. No. ED-94054D
APPROVED BY: DATE: <i>J. Yoshikawa June 12, 1996</i>		ISSUE June 14, 1996
		PAGE 10 Pages
		REPRESENTATIVE DIVISION OPTO-ELECTRONIC DEVICES DIV.

DEVICE SPECIFICATION FOR	Business dealing name
PHOTOCOUPLER	
MODEL No.	
PC817	

PC817X	PC817X6
PC817X1	PC817X7
PC817X2	PC817X8
PC817X3	PC817X9
PC817X4	PC817X0
PC817X5	

1. These specification sheets include materials protected under copyright of Sharp Corporation ("Sharp"). Please do not reproduce or cause anyone to reproduce them without Sharp's consent.

2. When using this product, please observe the absolute maximum ratings and the instructions for use outlined in these specification sheets, as well as the precautions mentioned below. Sharp assumes no responsibility for any damage resulting from use of the product which does not comply with the absolute maximum ratings and the instructions included in these specification sheets, and the precautions mentioned below.

(Precautions)

(1) This product is designed for use in the following application areas ;

- OA equipment    • Audio visual equipment    • Home appliances
- Telecommunication equipment (Terminal)    • Measuring equipment
- Tooling machines    • Computers

If the use of the product in the above application areas is for equipment listed in paragraphs (2) or (3), please be sure to observe the precautions given in those respective paragraphs.

(2) Appropriate measures, such as fail-safe design and redundant design considering the safety design of the overall system and equipment, should be taken to ensure reliability and safety when this product is used for equipment which demands high reliability and safety in function and precision, such as ;

- Transportation control and safety equipment (aircraft, train, automobile etc.)
- Traffic signals    • Gas leakage sensor breakers    • Rescue and security equipment
- Other safety equipment

(3) Please do not use this product for equipment which require extremely high reliability and safety in function and precision, such as ;

- Space equipment    • Telecommunication equipment (for trunk lines)
- Nuclear power control equipment    • Medical equipment

(4) Please contact and consult with a Sharp sales representative if there are any questions regarding interpretation of the above three paragraphs.

3. Please contact and consult with a Sharp sales representative for any questions about this product.

CUSTOMER'S APPROVAL

DATE \_\_\_\_\_

BY \_\_\_\_\_

DATE \_\_\_\_\_

PRESENTED BY           *T. M.*          

T. Matsumura,  
Department General Manager of  
Engineering Dept., II  
Opto-Electronic Devices Div.  
ELECOM Group  
SHARP CORPORATION

### 1. Application

This specification applies to the outline and characteristics of photocoupler Model No. PC817series.

### 2. Outline

Refer to the attached drawing No. CY6961K02.

### 3. Ratings and characteristics

Refer to the attached sheet, page 3 to 6.

### 4. Reliability

Refer to the attached sheet, page 7.

### 5. Incoming inspection

Refer to the attached sheet, page 8.

### 6. Supplement

6.1 Isolation voltage shall be measured in the following method.

- (1) Short between anode to cathode on the primary side and between collector to emitter on the secondary side.
- (2) The dielectric withstand tester with zero-cross circuit shall be used.
- (3) The wave form of applied voltage shall be a sine wave.  
(It is recommended that the isolation voltage be measured in insulation oil.)

## 6.2 Business dealing name

("○" mark indicates business dealing name of ordered product)

Ordered product	Business dealing name	Rank mark	Ic (mA)
	PC817X	A, B, C, D or no mark	2.5 to 30
	PC817X1	A	4.0 to 8.0
	PC817X2	B	6.5 to 13
	PC817X3	C	10 to 20
	PC817X4	D	15 to 30
	PC817X5	A or B	4.0 to 13
	PC817X6	B or C	6.5 to 20
	PC817X7	C or D	10 to 30
	PC817X8	A, B or C	4.0 to 20
	PC817X9	B, C or D	6.5 to 30
	PC817X0	A, B, C or D	4.0 to 30

Test conditions
$I_F=5mA$
$V_{CE}=5V$
$T_a=25^{\circ}C$

## 6.3 This Model is approved by UL.

Approved Model No. : PC817

UL file No. : E64380

## 6.4 This product is not designed against irradiation.

This product is assembled with electrical input and output.

This product incorporates non-coherent light emitting diode.

## 7. Notes

Refer to the attached sheet-1-1, 2.

## 3. Ratings and characteristics

## 3.1 Absolute maximum ratings

Ta=25°C

Parameter		Symbol	Rating	Unit
Input	*1 Forward current	$I_F$	50	mA
	*2 Peak forward current	$I_{FM}$	1	A
	Reverse voltage	$V_R$	6	V
	*1 Power dissipation	P	70	mW
Output	Collector-emitter voltage	$V_{CEO}$	35	V
	Emitter-collector voltage	$V_{ECO}$	6	V
	Collector current	$I_C$	50	mA
	*1 Collector power dissipation	$P_C$	150	mW
*1 Total power dissipation		$P_{tot}$	200	mW
*3 Isolation voltage		$V_{iso}$	5	kVrms
Operating temperature		$T_{opr}$	-30 to +100	°C
Storage temperature		$T_{stg}$	-55 to +125	°C
*4 Soldering temperature		$T_{sol}$	260	°C

\*1 The derating factors of absolute maximum ratings due to ambient temperature are shown in Fig. 1 to 4.

\*2 Pulse width  $\leq 100 \mu s$ , Duty ratio : 0.001 (Refer to Fig. 5)

\*3 AC for 1 min, 40 to 60%RH

\*4 For 10 s

## 3.2 Electro-optical characteristics

Ta=25°C

Parameter		Symbol	Condition	MIN.	TYP.	MAX.	Unit
Input	Forward voltage	$V_F$	$I_F=20\text{mA}$	-	1.2	1.4	V
	Peak forward voltage	$V_{FM}$	$I_{FM}=0.5\text{A}$	-	-	3.0	V
	Reverse current	$I_R$	$V_R=4\text{V}$	-	-	10	$\mu\text{A}$
	Terminal capacitance	$C_t$	$V=0, f=1\text{kHz}$	-	30	250	pF
Output	Dark current	$I_{CEO}$	$V_{CE}=20\text{V}, I_F=0$	-	-	100	nA
	Collector-emitter breakdown voltage	$BV_{CEO}$	$I_C=0.1\text{mA}$ $I_F=0$	35	-	-	V
	Emitter-collector breakdown voltage	$BV_{ECO}$	$I_E=10\mu\text{A}, I_F=0$	6	-	-	V
Transfer characteristics	Collector current	$I_C$	$I_F=5\text{mA}, V_{CE}=5\text{V}$	2.5	-	30	mA
	Collector-emitter saturation voltage	$V_{CE(sat)}$	$I_F=20\text{mA}$ $I_C=1\text{mA}$	-	0.1	0.2	V
	Isolation resistance	$R_{ISO}$	DC500V 40 to 60%RH	$5 \times 10^{10}$	$10^{11}$	-	$\Omega$
	Floating capacitance	$C_f$	$V=0, f=1\text{MHz}$	-	0.6	1.0	pF
	Cut-off frequency	$f_c$	$V_{CE}=5\text{V}, I_C=2\text{mA}$ $R_L=100\Omega, -3\text{dB}$	-	80	-	kHz
	Rise time	$t_r$	$V_{CE}=2\text{V}$ $I_C=2\text{mA}$	-	4	18	$\mu\text{s}$
	Fall time	$t_f$	$R_L=100\Omega$	-	3	18	$\mu\text{s}$

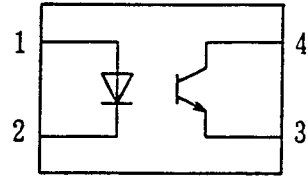
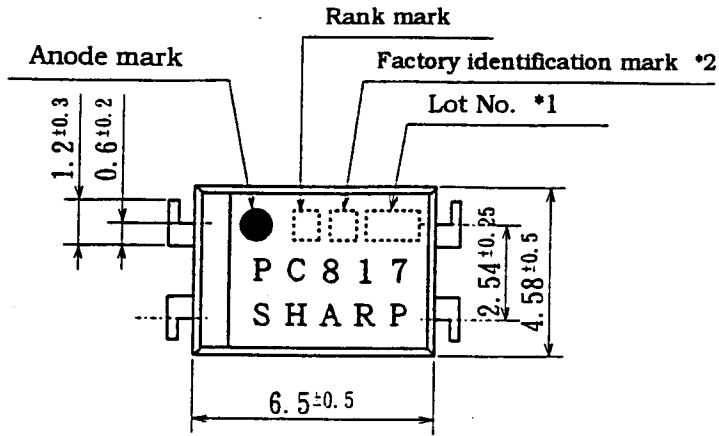

Pin Nos. and internal connection diagram

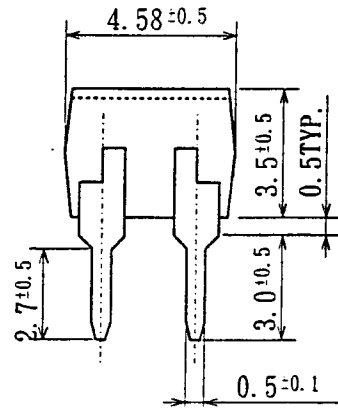
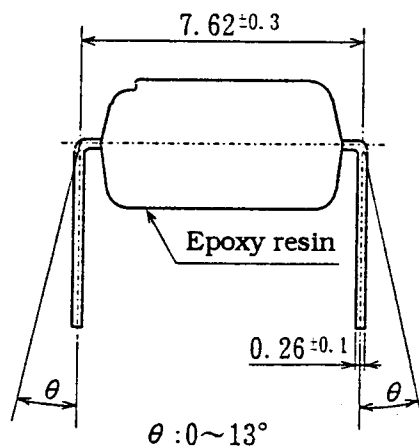

- \*1) 2-digit number shall be marked according to DIN standard.
- \*2) Factory identification mark shall be or shall not be marked.
- \*3) Marking is laser marking

UNIT : 1/1 mm	
Name	PC817 Outline Dimensions (Business dealing name : PC817X)
Drawing No.	CY6961K02

(Fig. 1) Forward current vs. ambient temperature

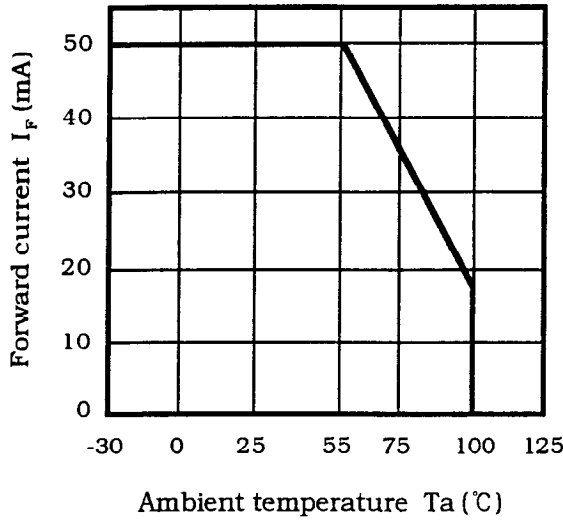

(Fig. 2) Diode power dissipation vs. ambient temperature

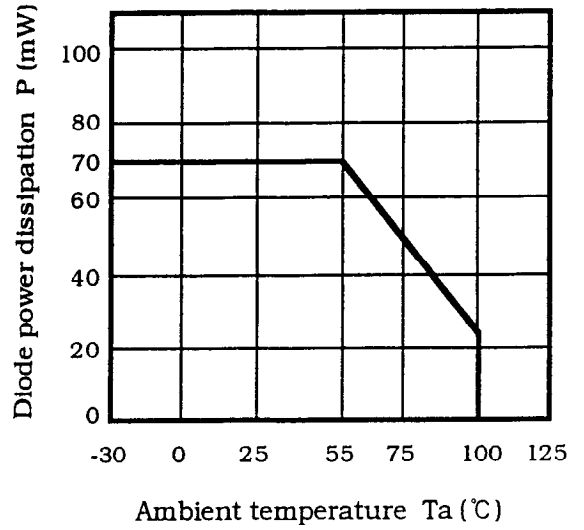

(Fig. 3) Collector power dissipation vs. ambient temperature

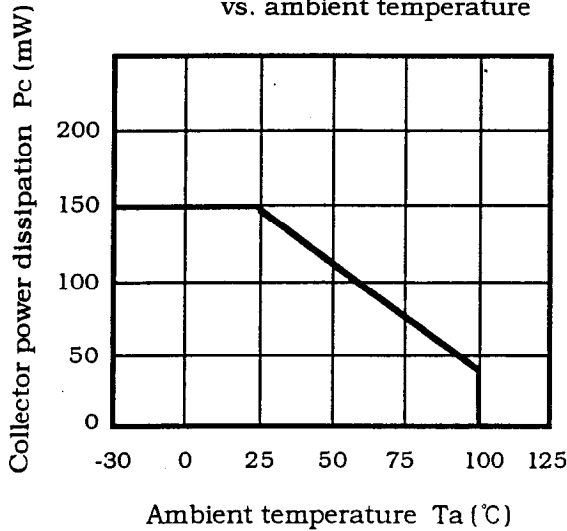

(Fig. 4) Total power dissipation vs. ambient temperature

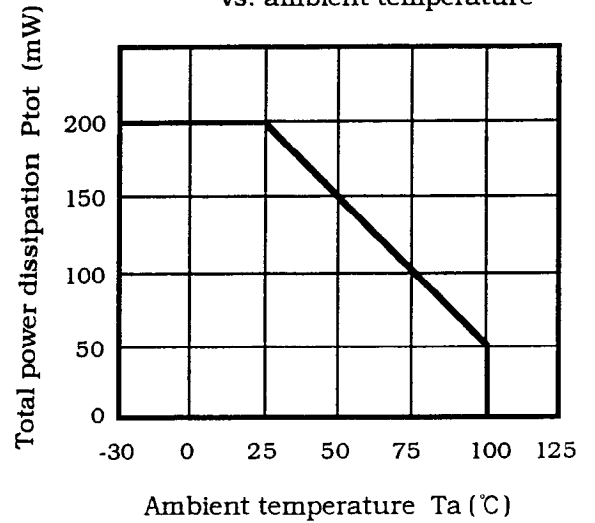

(Fig. 5) Peak forward current vs. duty ratio

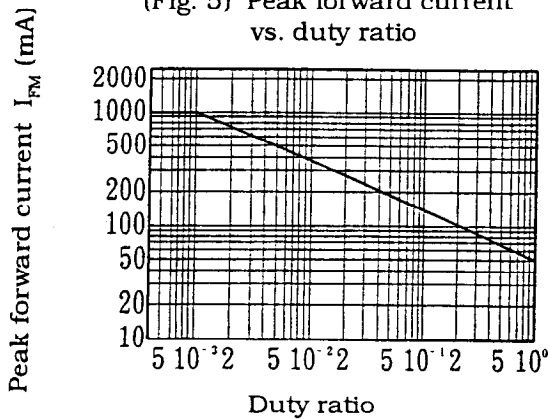

Pulse width ≤ 100 μs  
Ta = 25°C

## 4. Reliability

The reliability of products shall be satisfied with items listed below.

Confidence level : 90%

LTPD : 10%/20%

Test Items	Test Conditions *1	Failure Judgement Criteria	Samples (n)
			Defective(C)
Solderability *2	230°C, 5 s	—	n=11, C=0
Soldering heat	260°C, 10 s	$V_F > U \times 1.2$ $I_R > U \times 2$ $I_{CEO} > U \times 2$ $I_C < L \times 0.7$ $V_{CE(sat)} > U \times 1.2$  U : Upper specification limit  L : Lower specification limit	n=11, C=0
Terminal strength (Tension)	Weight : 5N 5 s/each terminal		n=11, C=0
Terminal strength (Bending) *3	Weight : 2.5N 2 times/each terminal		n=11, C=0
Mechanical shock	15000m/s <sup>2</sup> , 0.5ms 3 times/ ±X, ±Y, ±Z direction		n=11, C=0
Variable frequency vibration	100 to 2000 to 100Hz/4min 200m/s <sup>2</sup> 4 times/ X, Y, Z direction		n=11, C=0
Temperature cycling	1 cycle -55°C to +125°C (30min) (30min) 20 cycles test		n=22, C=0
High temp. and high humidity storage	+60°C, 90%RH, 1000h		n=22, C=0
High temp. storage	+125°C, 1000h		n=22, C=0
Low temp. storage	-55°C, 1000h		n=22, C=0
Operation life	$I_F = 50\text{mA}$ , $P_{tot} = 200\text{mW}$ $T_a = 25^\circ\text{C}$ , 1000h		n=22, C=0

\*1 Test method, conforms to JIS C 7021.

\*2 Solder shall adhere at the area of 95% or more of immersed portion of lead and pin hole or other holes shall not be concentrated on one portion.

\*3 Terminal bending direction is shown below.

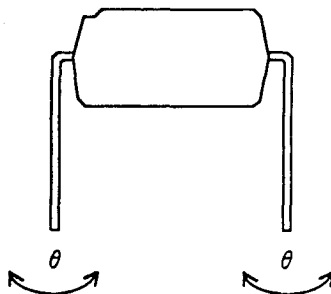



## 5. Incoming inspection

### 5.1 Inspection items

#### (1) Electrical characteristics

$V_F$ ,  $I_R$ ,  $I_{CEO}$ ,  $V_{CE(sat)}$ ,  $I_C$ ,  $R_{ISO}$ , Viso

#### (2) Appearance

### 5.2 Sampling method and Inspection level

A single sampling plan, normal inspection level II based on ISO 2859 is applied. The AQL according to the inspection items are shown below.

Defect	Inspection item	AQL (%)
Major defect	Electrical characteristics Unreadable marking	0.1
Minor defect	Appearance defect except the above mentioned.	0.4

Precautions for Photocouplers

## 1 For cleaning

- (1) Solvent cleaning : Solvent temperature 45°C or less  
Immersion for 3 min or less
- (2) Ultrasonic cleaning : The affect to device by ultrasonic cleaning is different by cleaning bath size, ultrasonic power output, cleaning time, PWB size or device mounting condition etc. Please test it in actual using condition and confirm that doesn't occur any defect before starting the ultrasonic cleaning.

Applicable solvent : Ethyl alcohol, Methyl alcohol  
Freon TE · TF, Diflon-solvent S3-E

Please refrain form using Chloro Fluoro Carbon type solvent to clean device as much as possible since it is internationally restricted to protect the ozonosphere. Before you use alternative solvent you are requested to confirm that it does not attack package resin.

2. The LED used in the Photocoupler generally decreases the light emission power by operation. In case of long operation time, please design the circuit with considering the degradation of the light emission power of the LED. (50%/5years)

3. Precautions for Soldering Photocouplers

- (1) In case of soldering to lead  
260°C 10 s or less

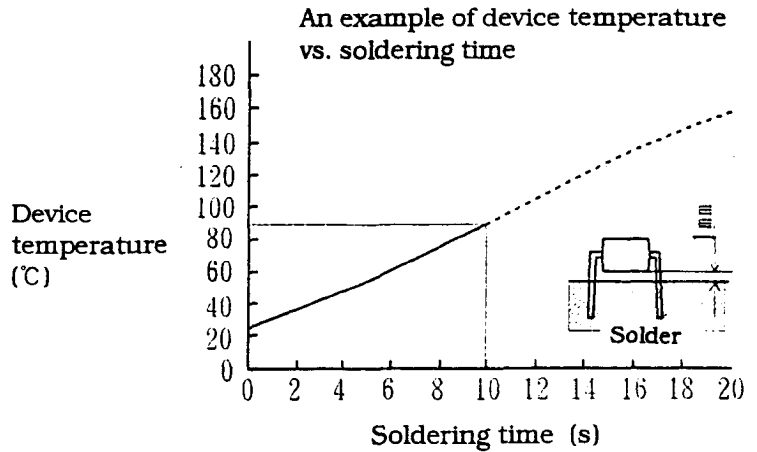

- (2) If solder reflow :

It is recommended that only one soldering be done at the temperature and the time within the temperature profile as shown in the figure.

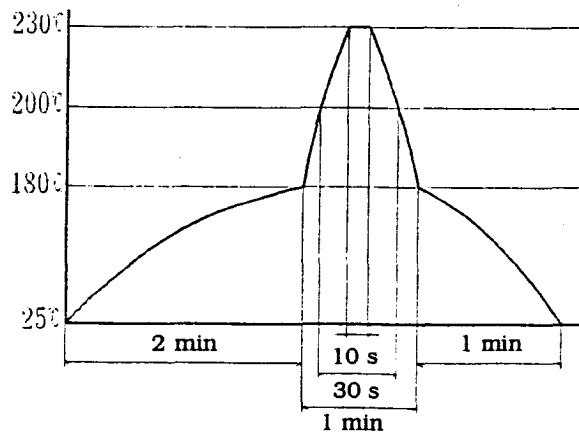

- (3) Other precautions

An infrared lamp used to heat up for soldering may cause a localized temperature rise in the resin. So keep the package temperature within that specified in Item (2). Also avoid immersing the resin part in the solder.